

Astragals

Meeting Stile Seals for Frameless Glass

RP42, RP103, RP104



Clear polycarbonate astragal and perimeter seals specifically designed for frameless glass doors. The woven pile sealing strip is combined with a weather fin to form an effective weather and energy seal.

Use in conjunction with Raven brush strip door bottom seals RP2b, RP74 and threshold plates.

Location:

RP42 Meeting stiles of 15mm thick frameless glass doors.

RP103 Meeting stiles of 10mm thick frameless glass doors.

RP104 Meeting stiles of 12mm thick frameless glass doors.

Min/Max Gap: 7mm to 8mm (prior to installation).

Fixing: Self adhesive. *Note: Contact surface must be clean, smooth and if painted, well cured. Self adhesive seals will not adhere to oiled or alkyd finishes or to easy clean wash and wear paint surfaces.*

Seal: Clear high impact UV stabilised polycarbonate body with black polypropylene pile with felt weather fins.

Sizes: 3000mm.

Approvals

Energy NCC Pt. 3.12.3.3 & J3.4.

RP42

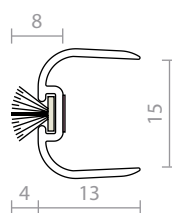

RP103

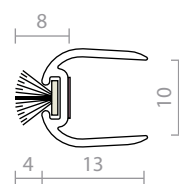

RP104

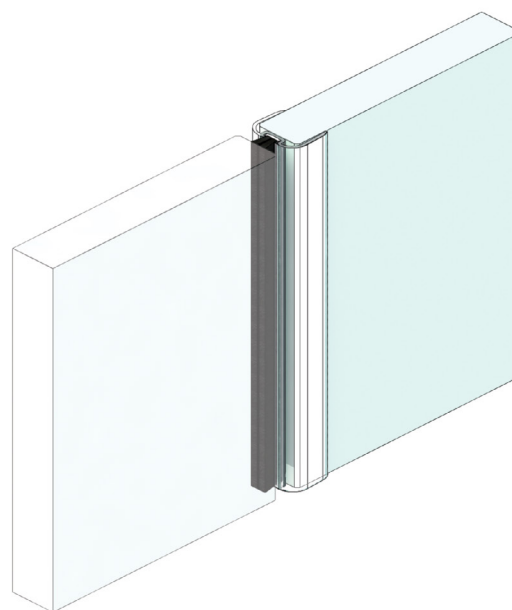
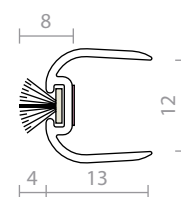

RP79, RP79Si, RP79H, RP88



Aluminium astragal seals designed for frameless glass doors. The woven pile sealing strip in RP79 and RP88 is combined with a weather fin to form an effective weather and energy seal. RP79Si utilises silicon rubber fins for medium temperature smoke door applications.

Use in conjunction with Raven brush strip door bottom seals RP2b, RP74 and threshold plates.

Location:

RP79, RP79Si, RP79H Meeting stiles of 12mm thick frameless glass doors.

RP88 Meeting stiles of 10mm thick frameless glass doors.

Min/Max Gap:

RP79, RP79Si, RP88 8mm to 9mm (prior to installation).

RP79H 8mm to 12mm (prior to installation).

Finish:

RP79, RP79H, RP88 Satin clear (silver) anodised aluminium (15µm).

RP79Si Black anodised aluminium (15µm).

Fixing: Self adhesive. *Note: Contact surface must be clean, smooth and if painted, well cured. Self adhesive seals will not adhere to oiled or alkyd finishes or to easy clean wash and wear paint surfaces.*

Seal:

RP79, RP88 Black polypropylene pile with felt weather fins.

RP79Si RP371Si. Grey silicon rubber (SE).

RP79H RP640. Black TPE.

Sizes: Available in stock lengths.

Approvals

Energy NCC Pt. 3.12.3.3 & J3.4.

RP79Si M200C ≤40 BAL

Fire Gasket flammability index 1 when tested to AS1530.2.

Smoke NCC Spec. C3.4 for smoke doors.

RP79H M200C ≤40 BAL

Fire Gasket flammability index ≤ 5 when tested to AS1530.2.

Smoke NCC Spec. C3.4 for smoke doors

RP79

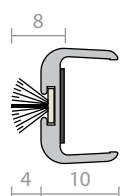

RP88

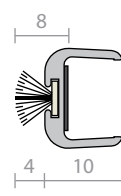

RP79Si

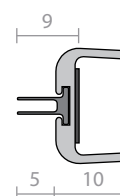

RP79H

